

# Tork Bin 5 Litre

**B3**

1.

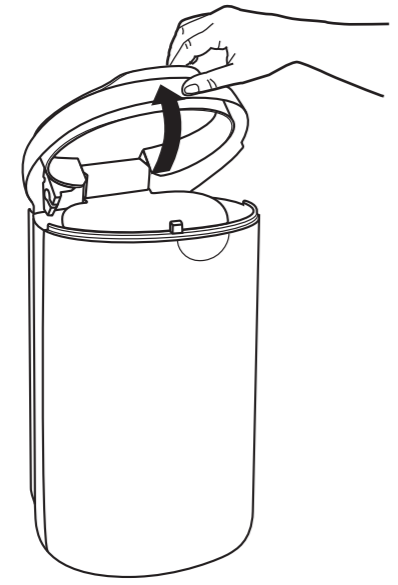

2.

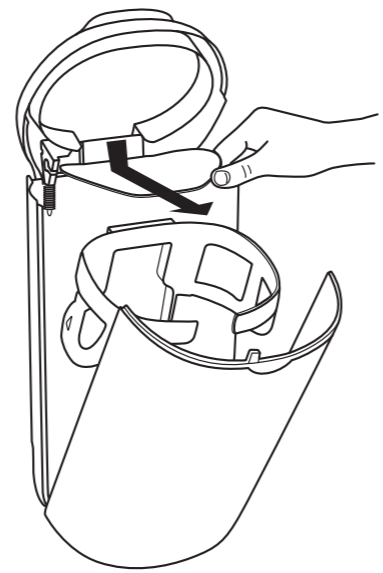

3.

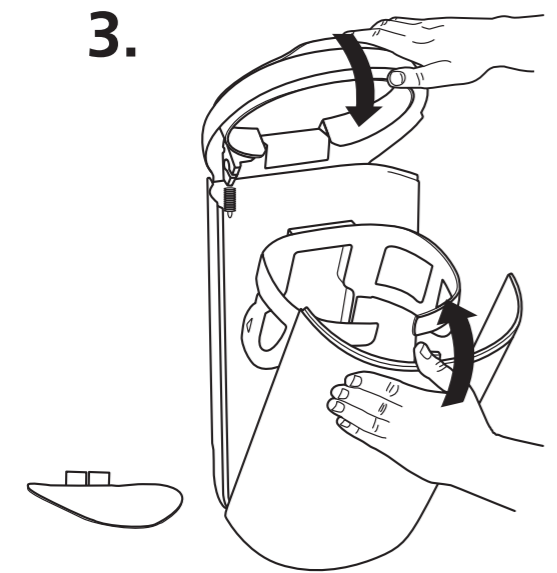

4.

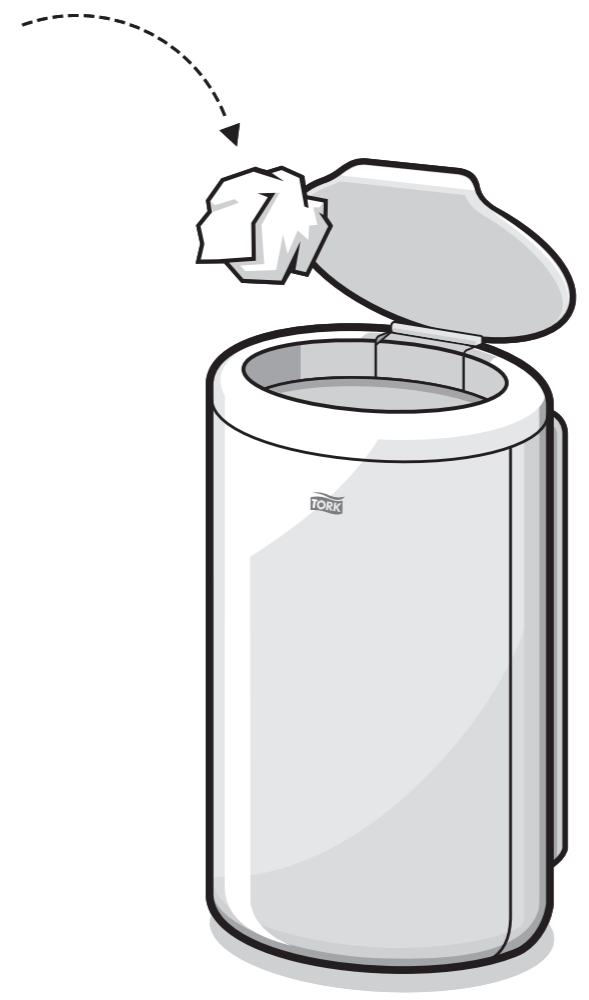
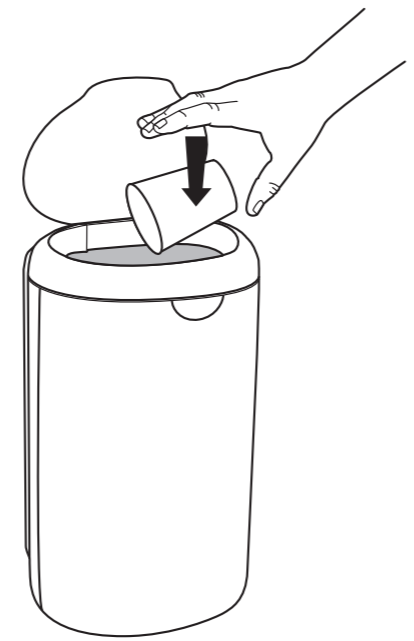

 **essity** Manufactured by Essity Hygiene and Health AB  
SE-40503 Göteborg, Sweden  
Visiting address: Mölndals Bro 2, Mölndal  
www.essity.com, www.torkglobal.com  
Made in Hungary  
Patents/Brevets/Patentes: www.essity.com/patents  
Essity UK Limited  
Southfields Road, Dunstable,  
Bedfordshire, LU6 3EJ, UK

[www.torkglobal.com](http://www.torkglobal.com)



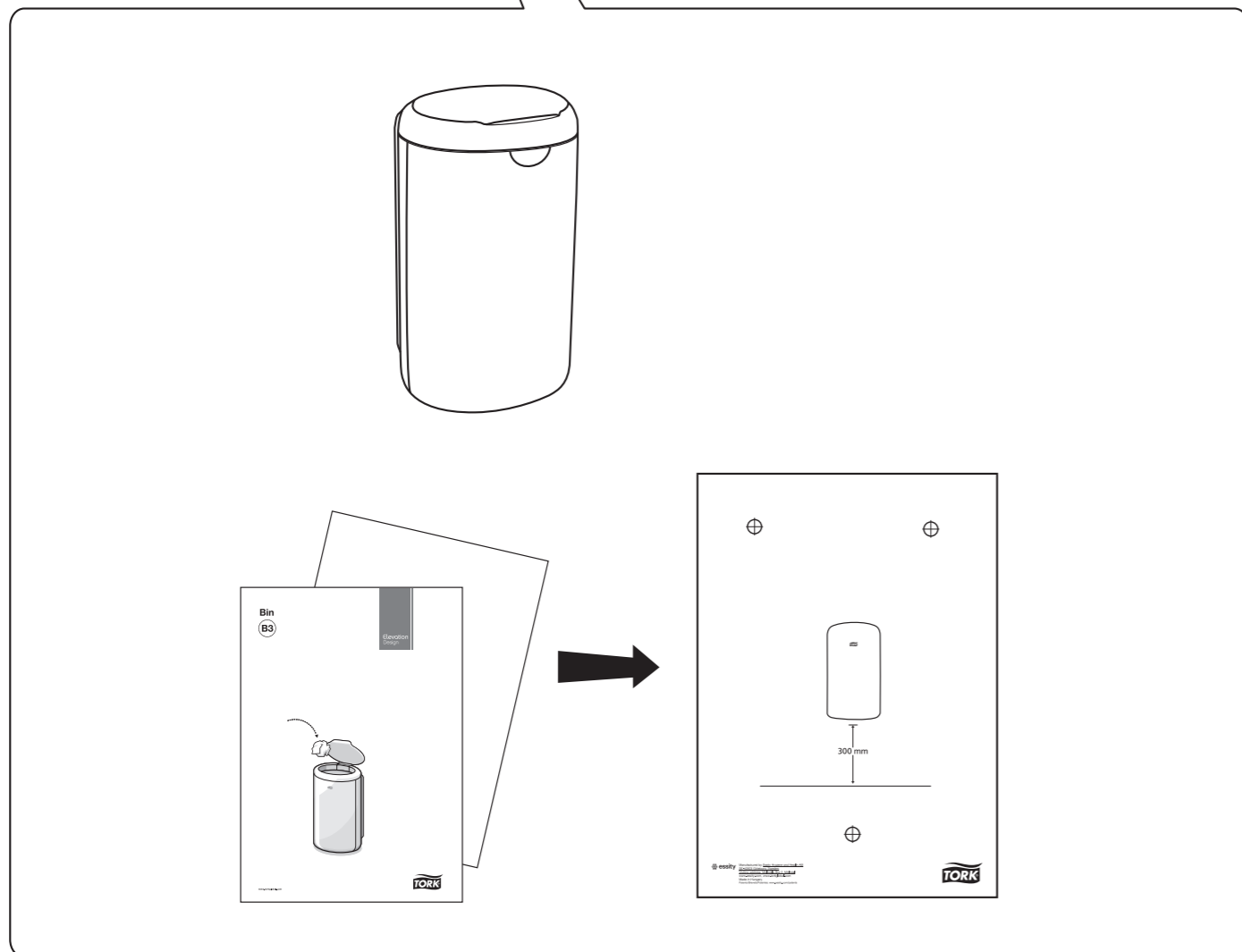
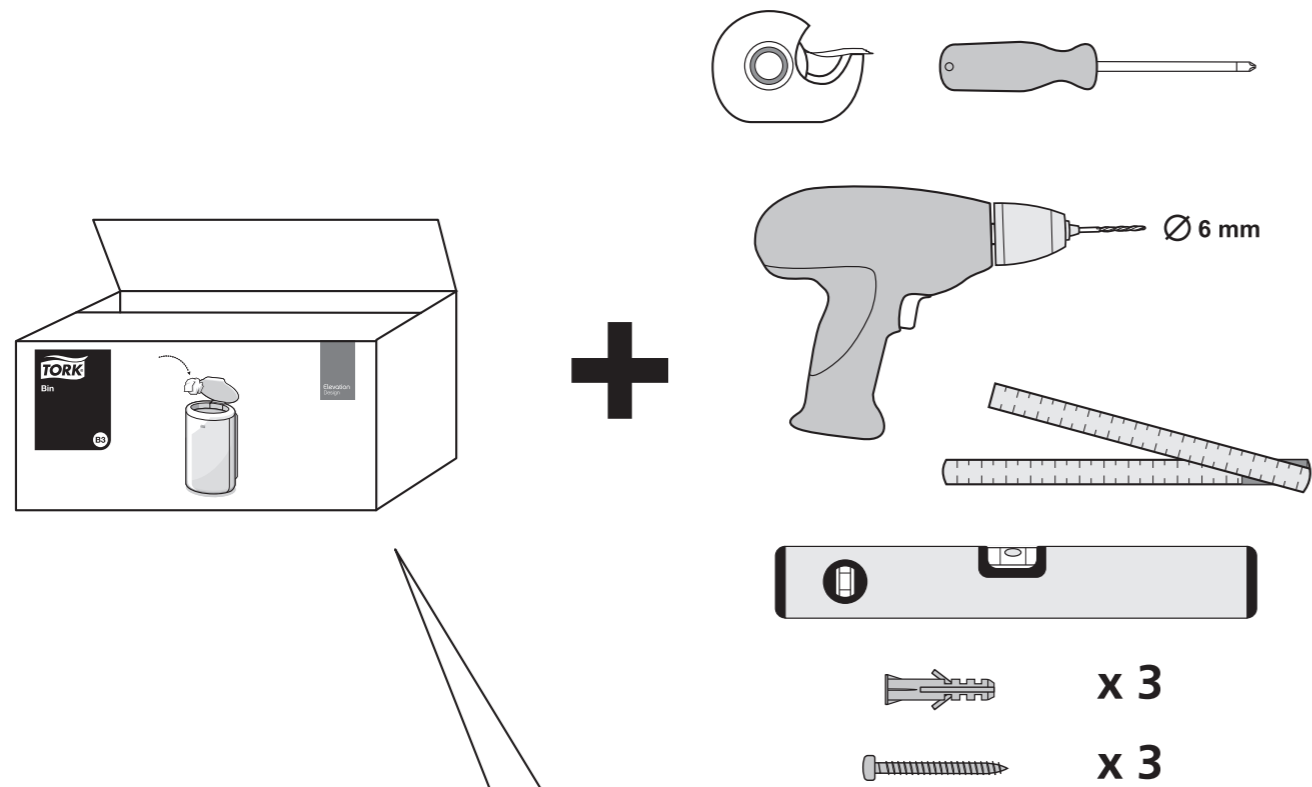

1.

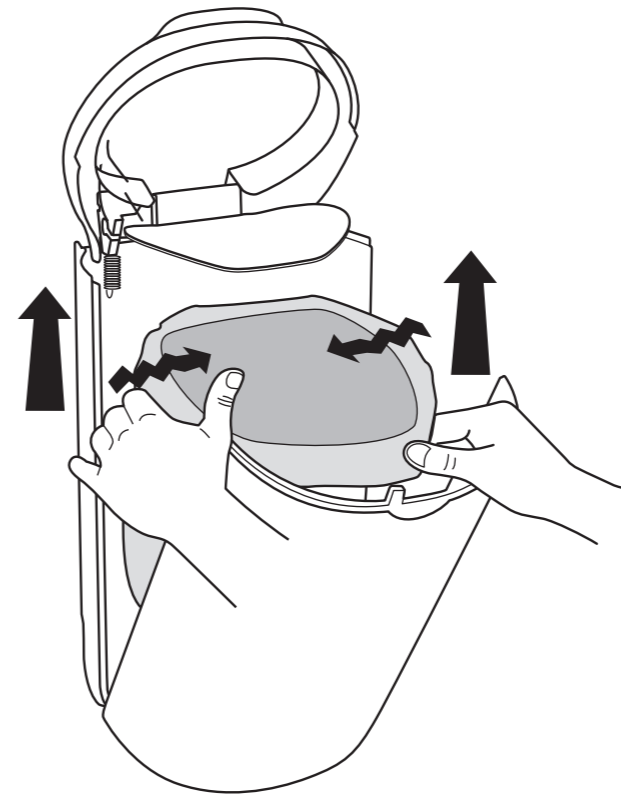

2.

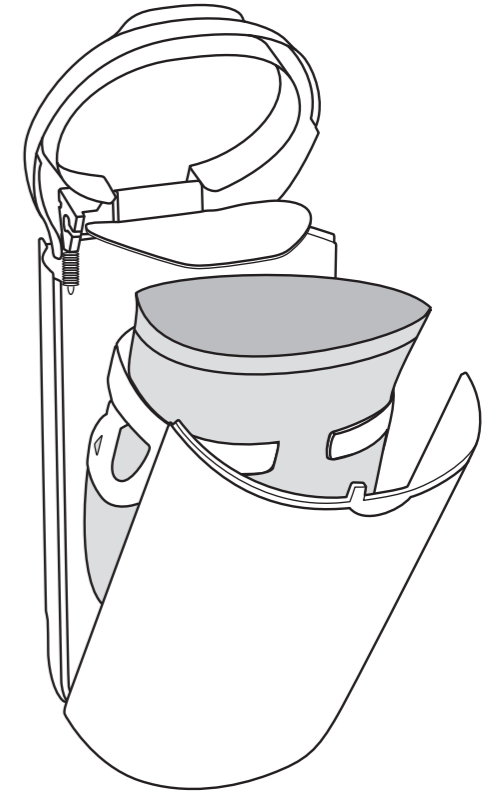

3.

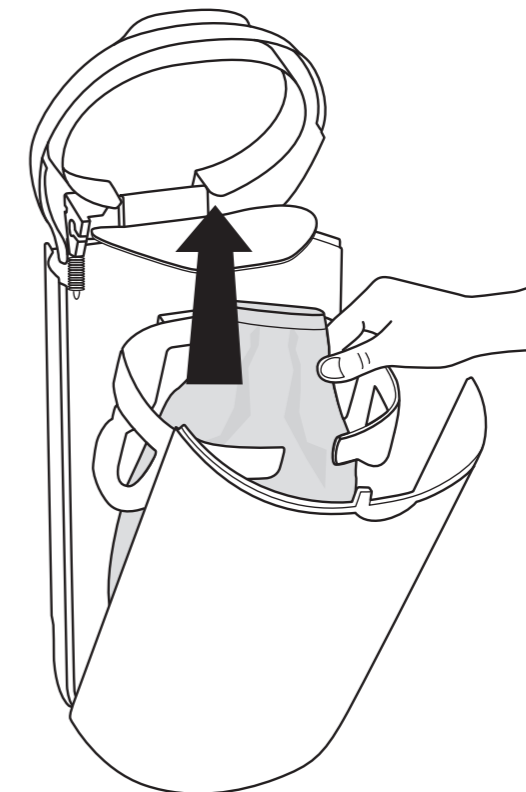

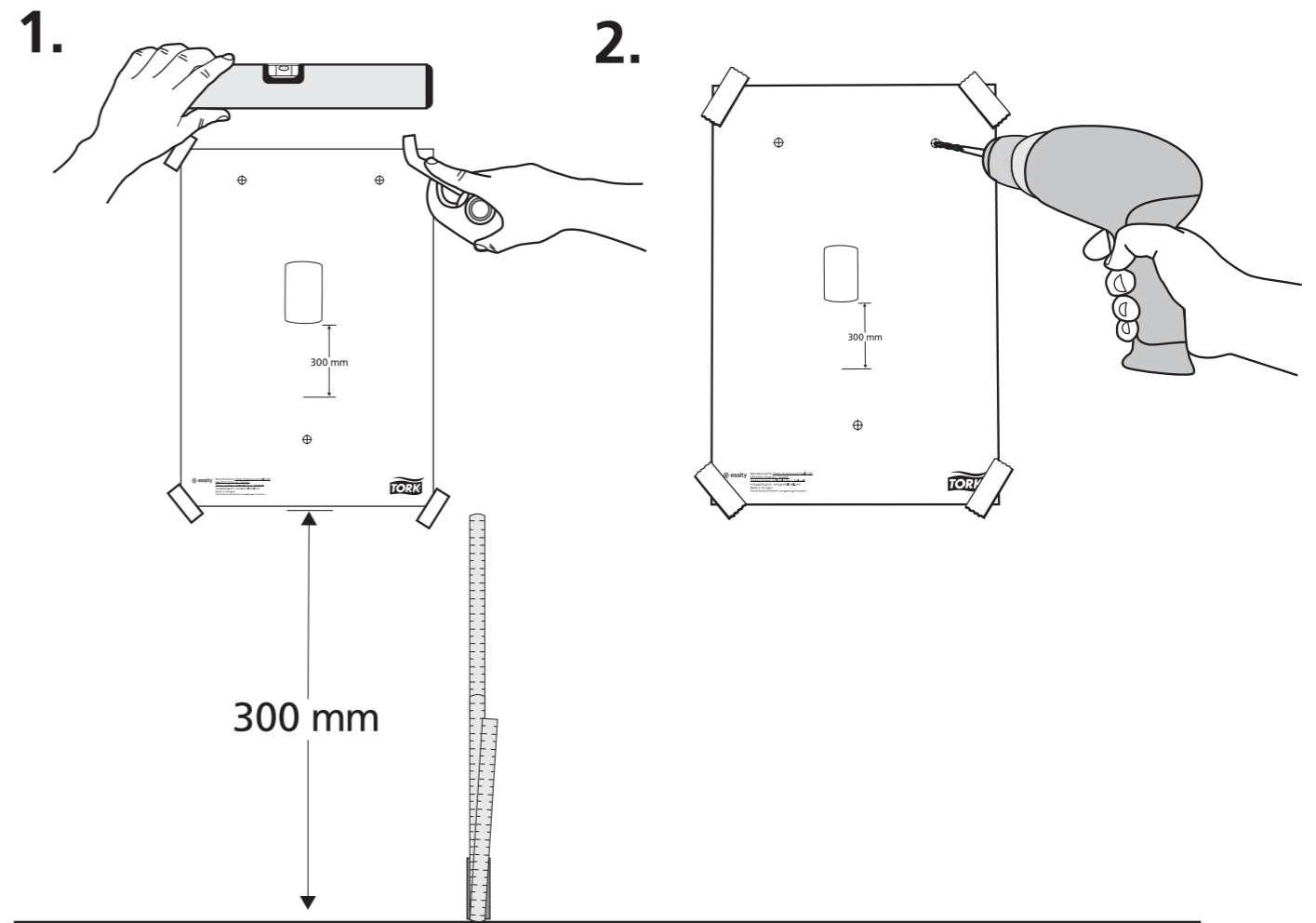

 x 3     x 3

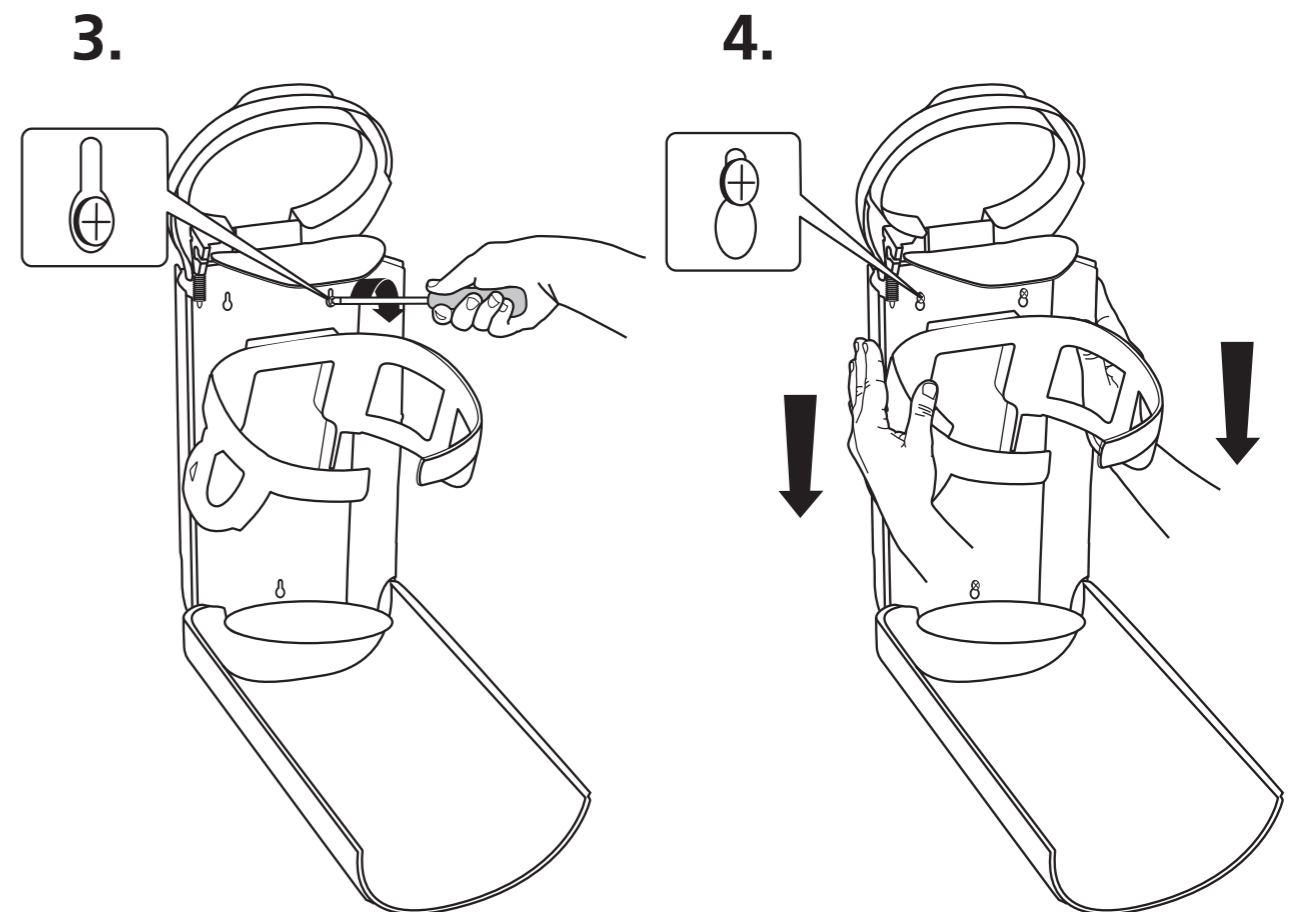

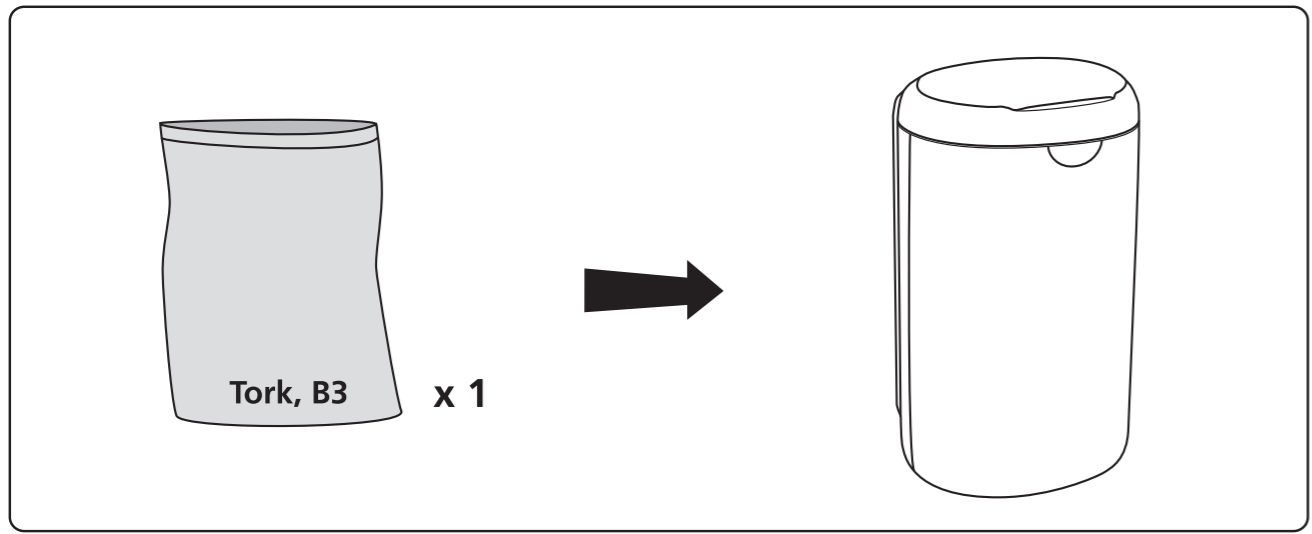

1.

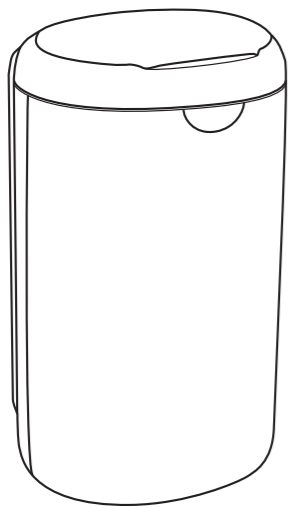

2.

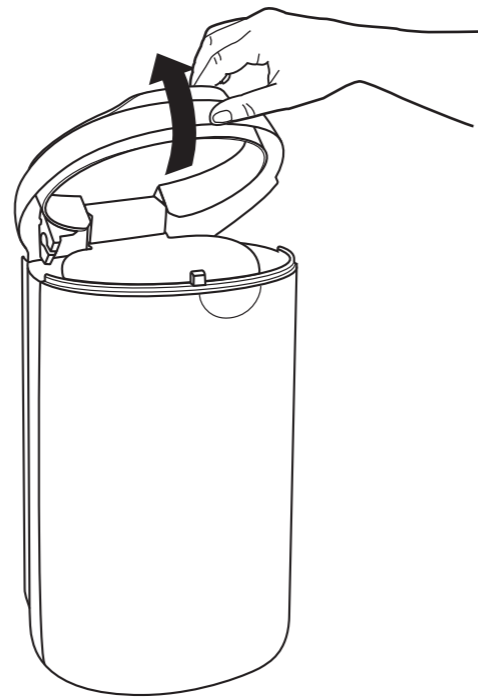

3.

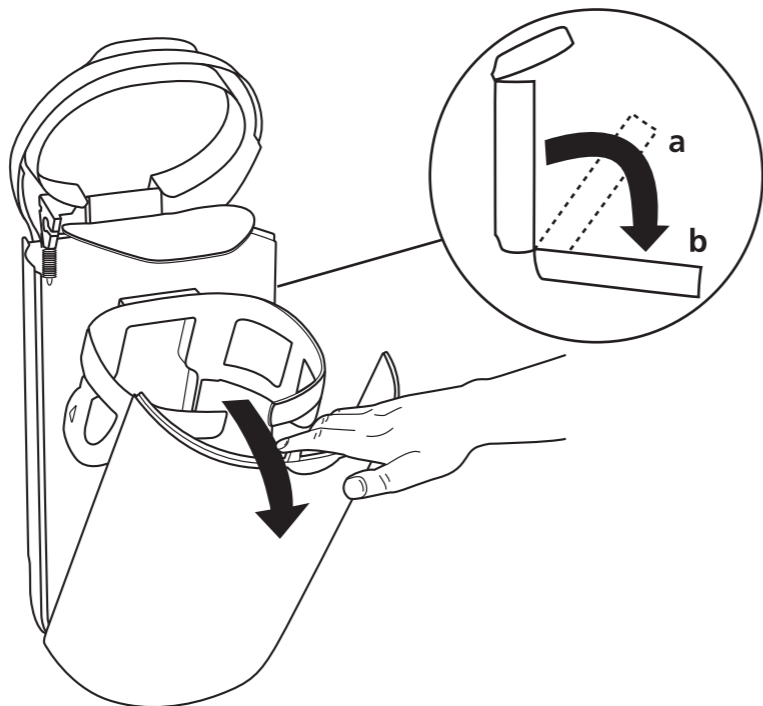

4.

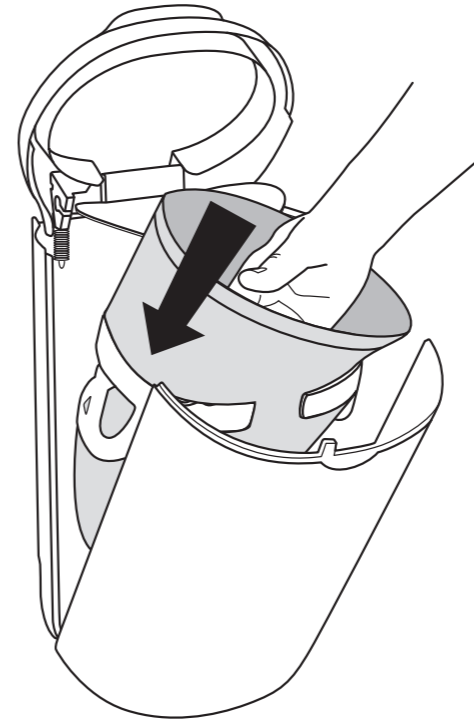

5.

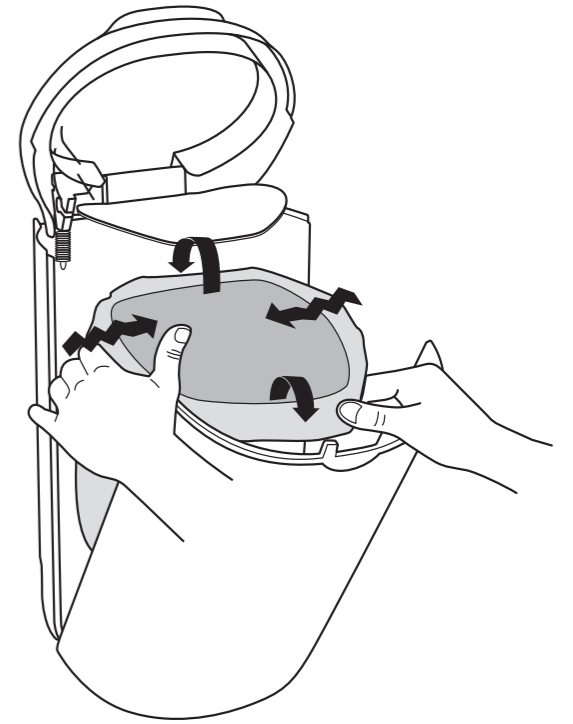

6.

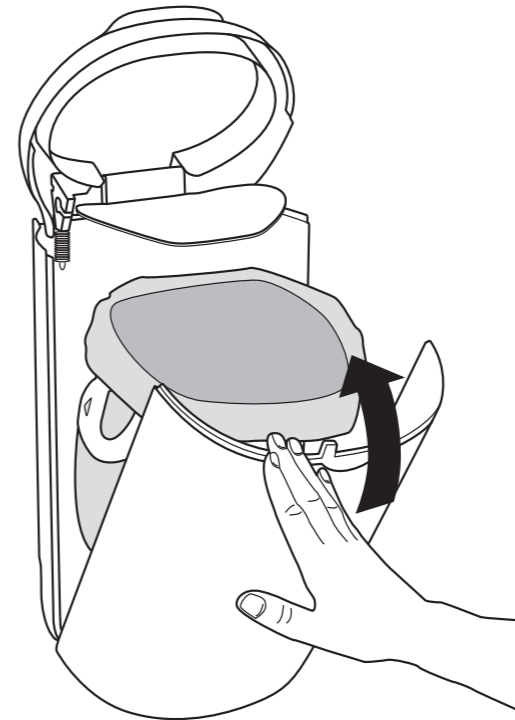

7.

